

**KAWASAKI STEEL TECHNICAL REPORT**

No.45 (November 2001)

"Developed Machinery Maintenance Technology  
in Steelmaking Plant"

---

**Maintenance-Free Technology for Hydraulic Equipment**

# Maintenance-Free Technology for Hydraulic Equipment\*

*Synopsis:*

[The following text is completely obscured by heavy black redaction bars.]

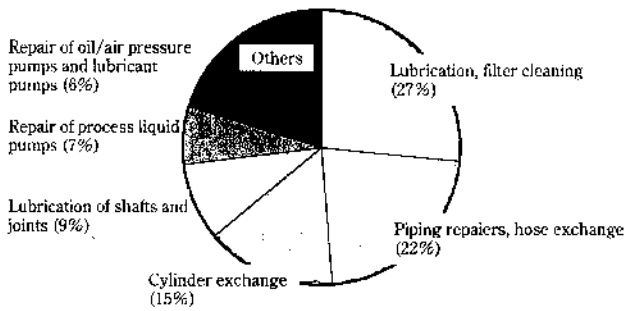
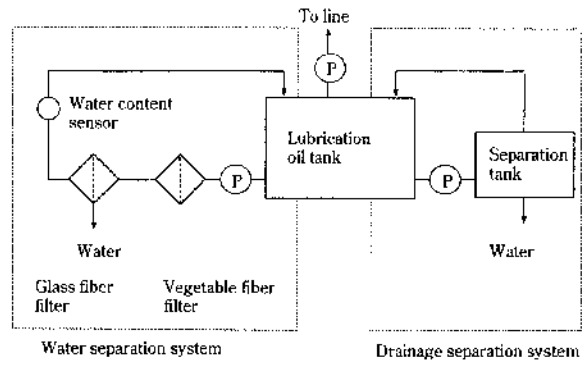

Fig. 1 Profile of works related to hydraulic equipment



related to hydraulic equipment in cold rolling mills. To realize maintenance-free for hydraulic equipment, it is necessary to extend the cycle of filter exchanges, extend the lives of cylinders and pumps, and extend the lubricating cycle of shafts and joints. It should be noted that the breakdown of work related to hydraulic equipment in the iron- and steelmaking plants is virtually the same as that in the cold rolling mill, and similar countermeasures are therefore necessary.<sup>2)</sup>

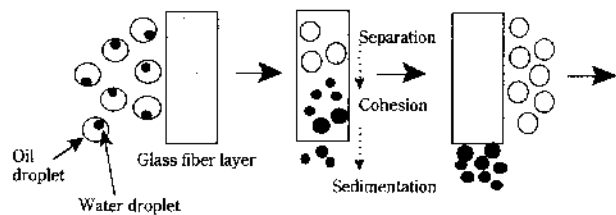
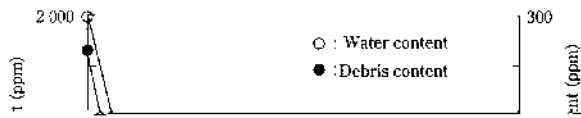
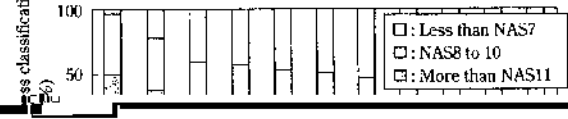
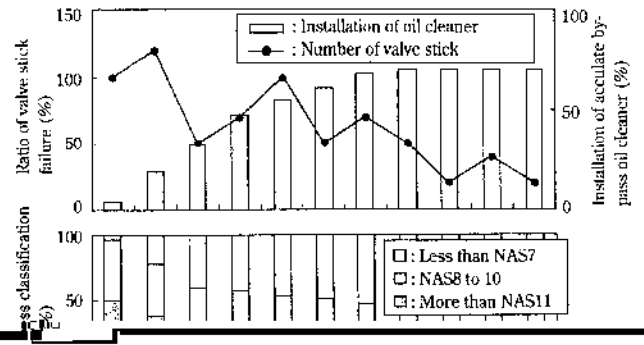
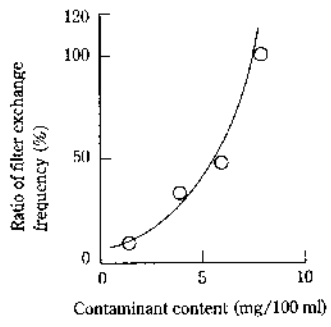
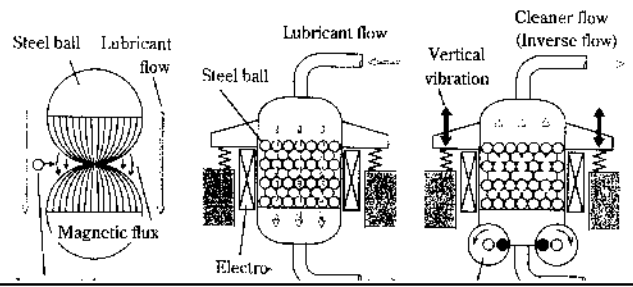
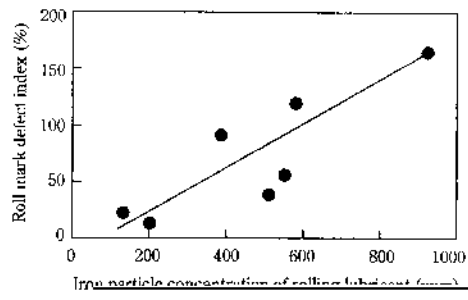

Fig. 2 Mechanism of water removal filter



expected. Because the depth element filter has an extremely large capacity of foreign matter capture and can remove both solid particles and oxidized products efficiently, it can also be used for water purification in





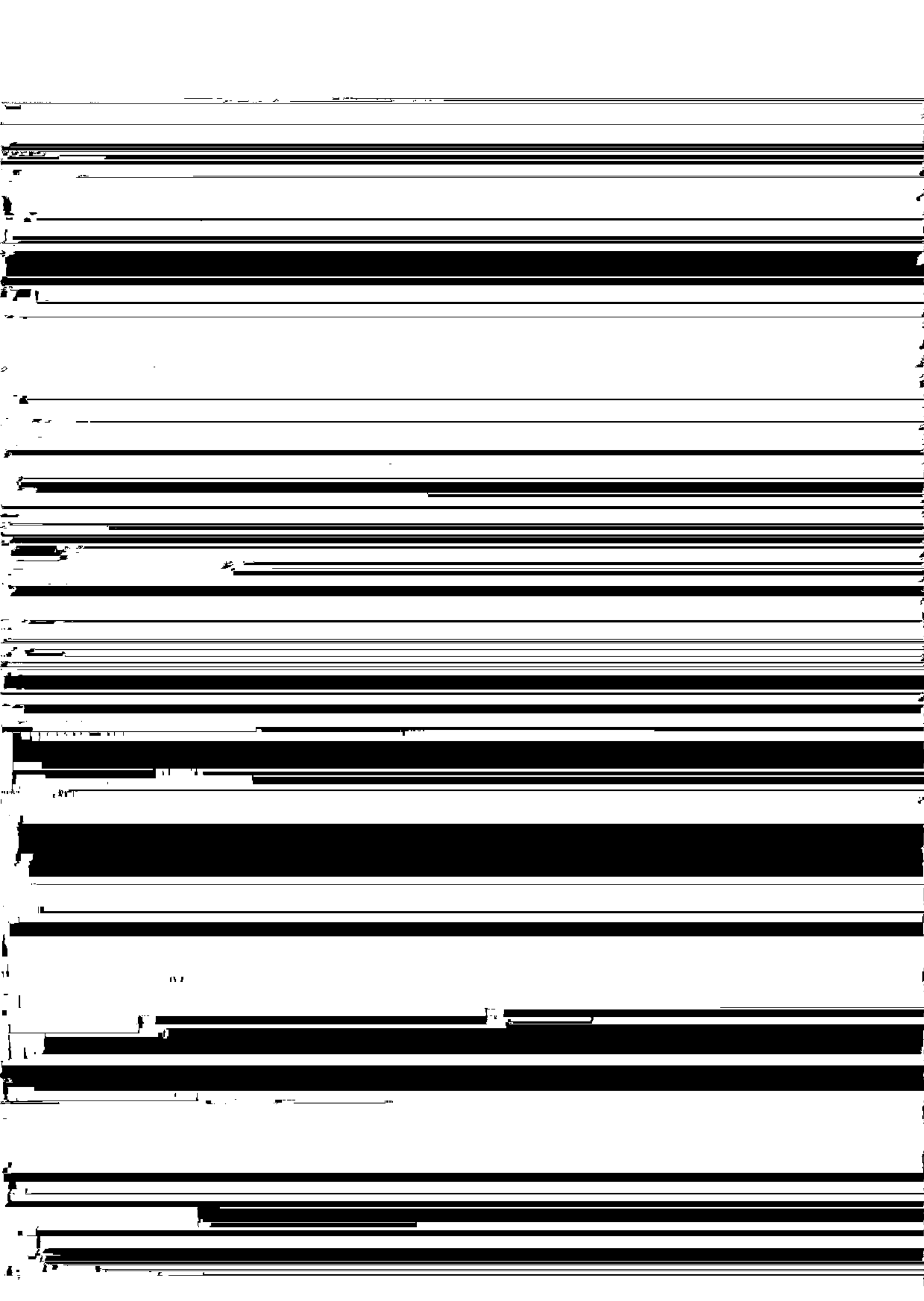

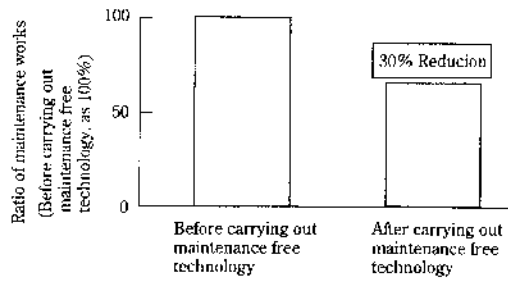

Fig. 20 Transition of ratio of maintenance works at hydraulic equipment

ment of materials and equipment will be necessary in order to achieve even longer equipment life. In any case, however, joint efforts by the makers and users of machinery, hydraulic equipment and fluids, bearings, seals, lubricants, and other components and materials will be required.

#### References

- 1) I. Takimoto, N. Ogasawara, and H. Horyoda: *Kawasaki Steel Technical Report*, (2001)45, 3
- 2) K. Kawashima: *Tribology Kenkyukai* 11(2000) 29

hydraulic equipment, it was possible to...

Takahashi: *Current Advances in Materials and Processes*,

mance work related to the hydraulic equipment has...